

# GDF46-18Z/2.2 380V Outline diagram

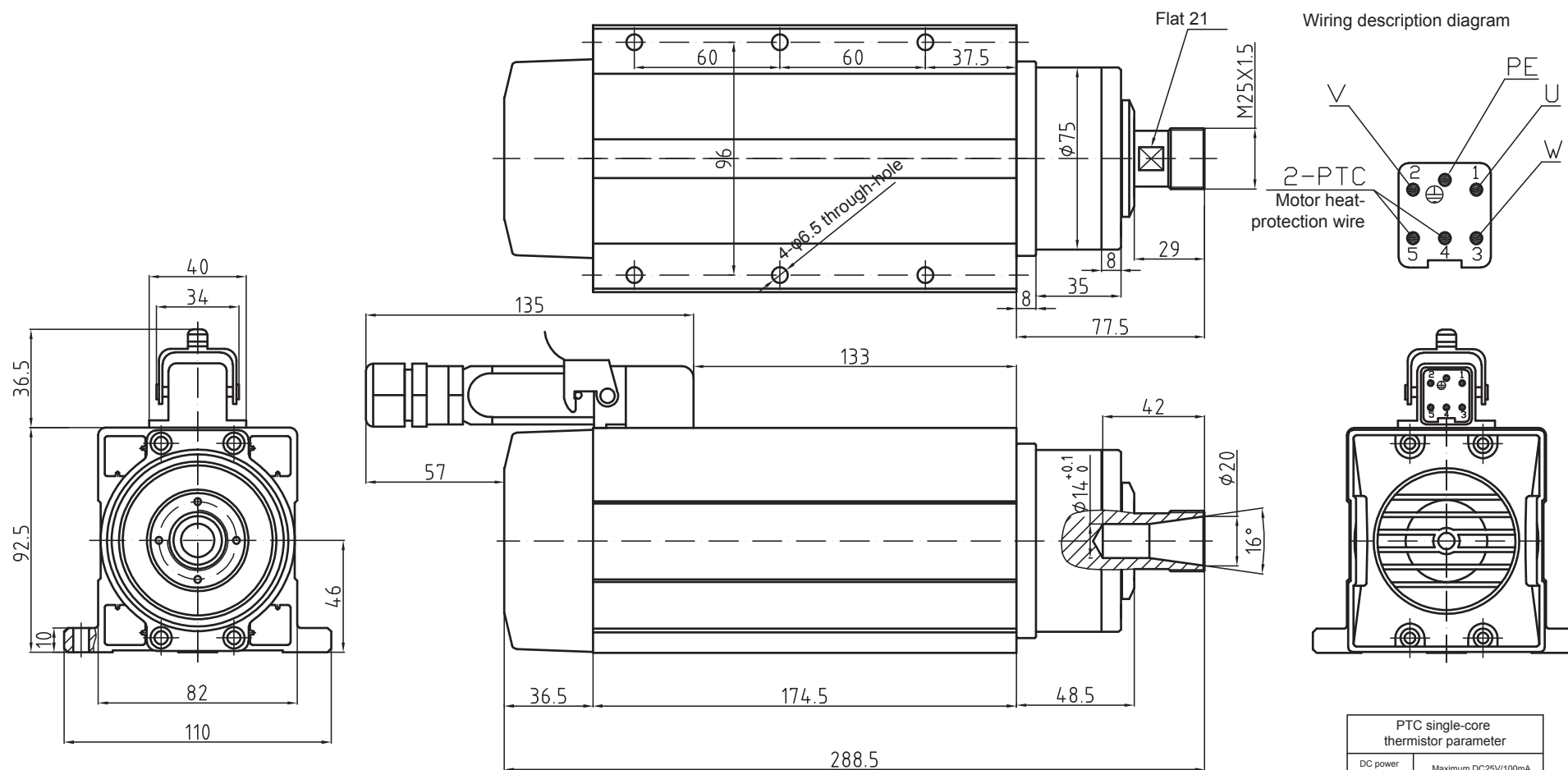

## GDF46-18Z/2.2

Power	2.2 kw	Weight: 7KG
Voltage	380 V	ER nut: ER20
Current	4.4 A	Cooling method: air cooling
Frequency	300 Hz	Bearing lubrication method: grease lubrication
Rotating speed	18000 r/min	High-precision angular contact ball bearing: 2×7005C P4/1×6002V P5
		Rotating direction: anticlockwise from the shaft extension end

Special attention: thread locking adhesive shall be applied or the spring washer shall be added to prevent the looseness during the installation of the fastening screw!

PTC single-core thermistor parameter	
DC power supply	Maximum DC25V/100mA
-20~25℃	≤100Ω
≤90℃	≤250Ω
105℃	≤550Ω
110℃	Rated operating temperature
115℃	≥1330Ω
≥125℃	≥4KΩ
≤160℃	Maximum storage temperature