

View A

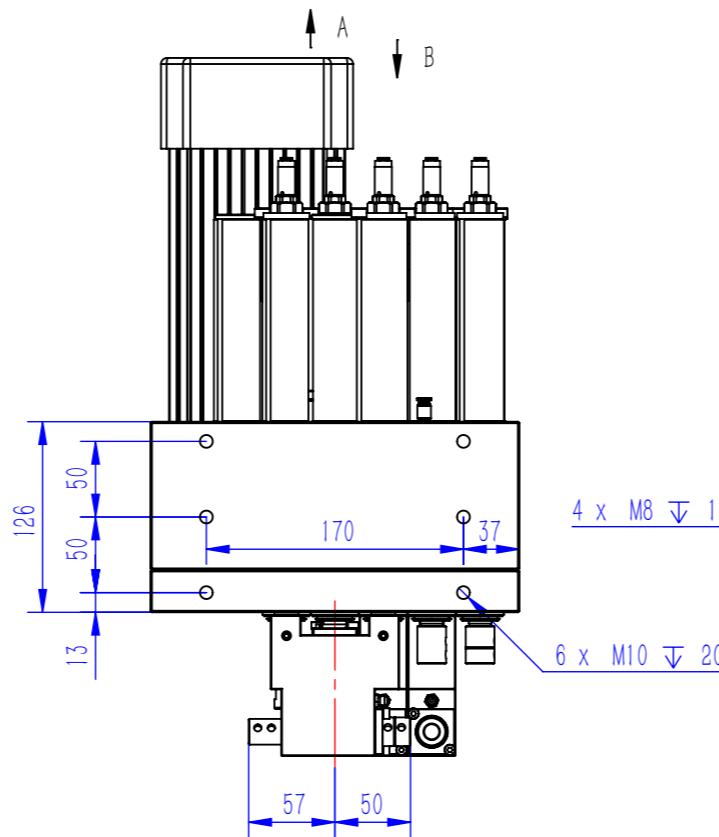

View B

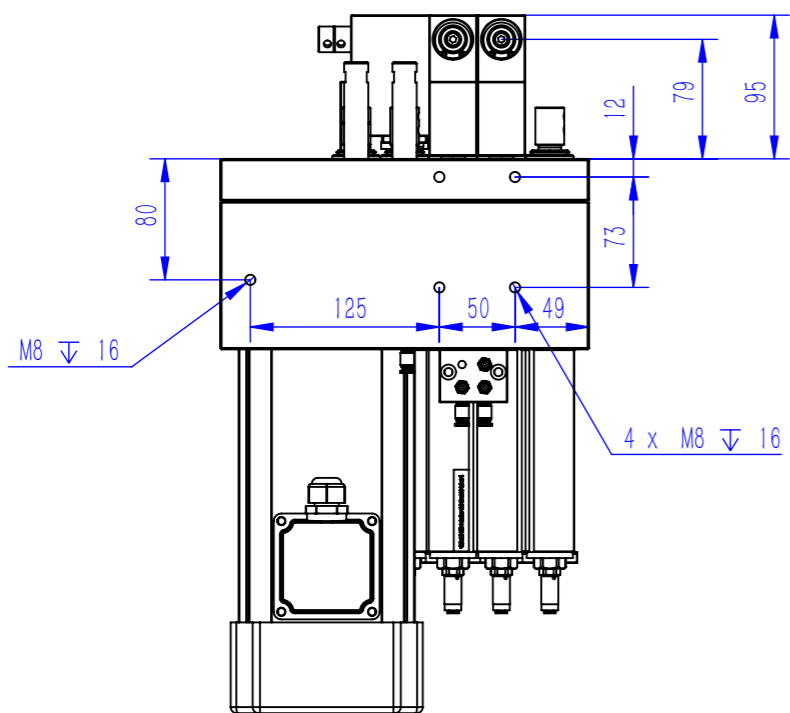
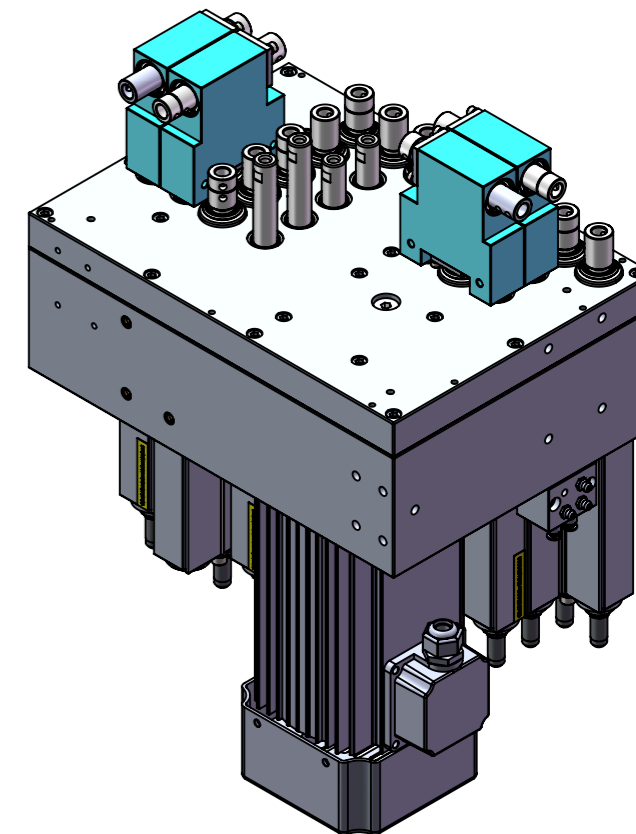
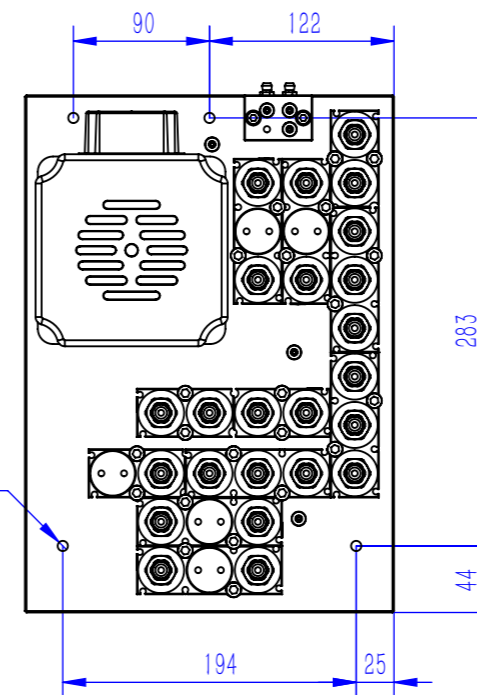

CNC Boring Heads parameters		Motor parameters	
Vertical shaft speed	4500rpm	Motor power	3HP 2.2KW
Horizontal shaft speed	4500rpm	Motor voltage	220/380V
Stroke	68mm	Motor rated frequency	50/60Hz
Air pressure	0.65-0.8MPa	Motor rated speed	2800/3400rpm
Lubrication grease	KLUBER ISOFLEX TOPAS L 32 N		
Tool interface	∅10mm	Installation depth	20mm

Note: Please connect the motor for forward rotation but not reverse rotation. The shaft with scribed line is reverse rotation, and the shaft without scribed line is forward rotation. Please install the drill correctly.

Jiangsu HQD spindle motor Co., Ltd
HQP-V12H4F4R
PZ43H10A
V01